

TRIMO

Trimless Downlight

Installation structure

Due to its installation design, Trimo is supplied in a dual-lid package.

1- Ring installation

Open lid No. 1 and install the mounting ring



2- Body installation

After installing the ring and completing the ceiling finishing (putty and paint), open lid No. 2, remove the main body, and install the luminaire



Box contents

- A-Mounting ring
- B-luminaire body
- C-terminal block
- D-driver

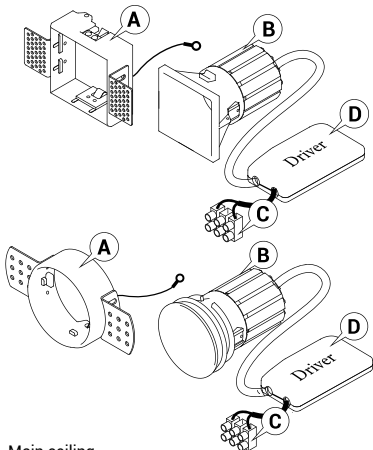

Main ceiling

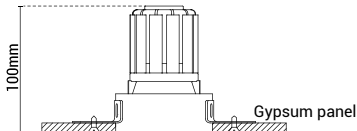

Cutting the ring
location in the ceiling

1

$\phi 80$ mm

80 mm 80 mm

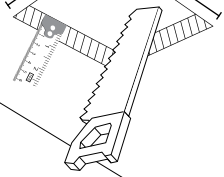
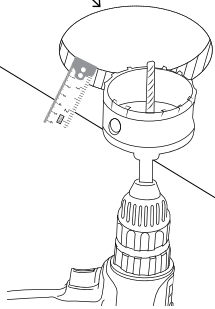

Adjusting the L-shaped
brackets according to
the gypsum board
thickness

2

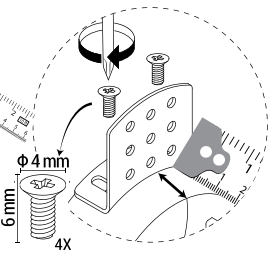
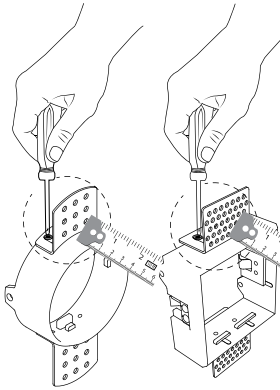

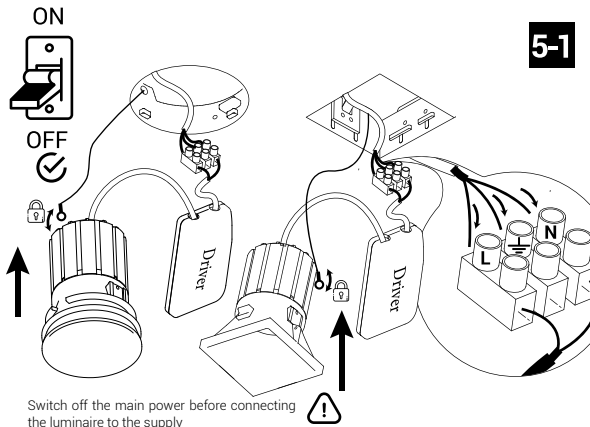

Switch off the main power before connecting the luminaire to the supply

Connecting the luminaire to the DALI smart system 5-2

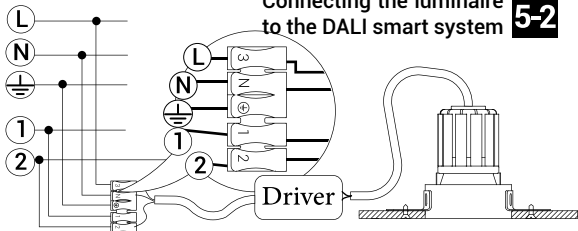

Connecting the dimmable luminaire via push button **5-3**

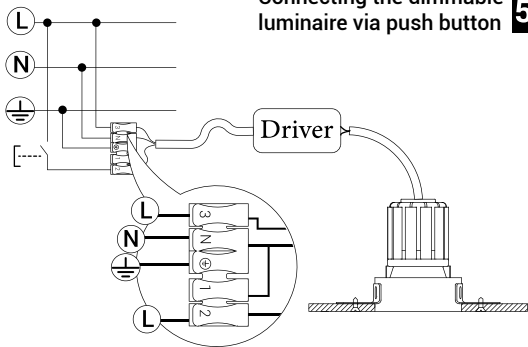

Adjusting the main body groove with the L-shaped brackets **6**

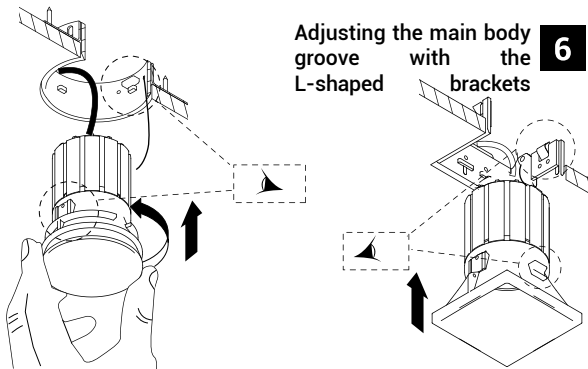

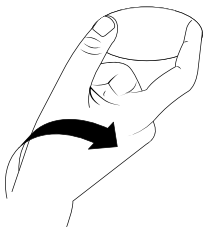

With a simple twist

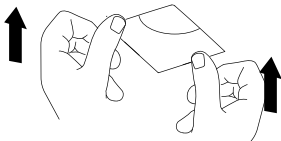

With a click

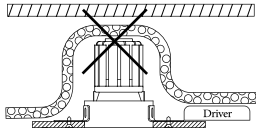
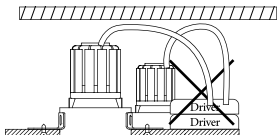
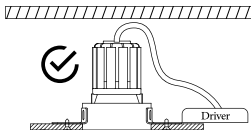
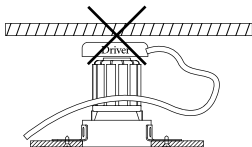

The luminaire must not be covered with any insulating materials



**Technical
support**

0 2 1 - 7 9 9 2 4

en.nooraneh.com